

Friesland Flat roof

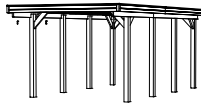

314x555cm



314034

314x708cm

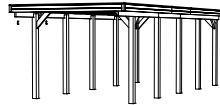

314058

314x860cm

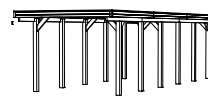

314072

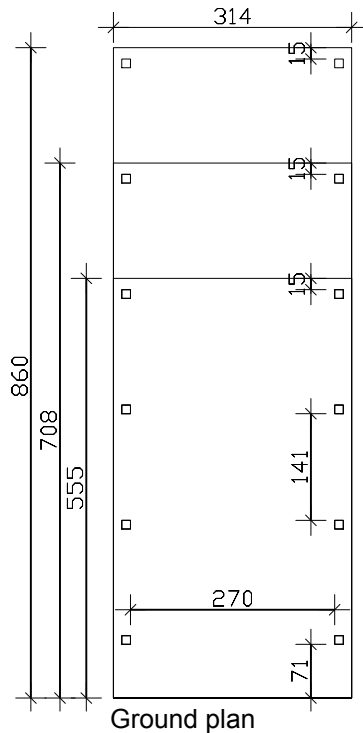

Including anchors for casting into concrete !

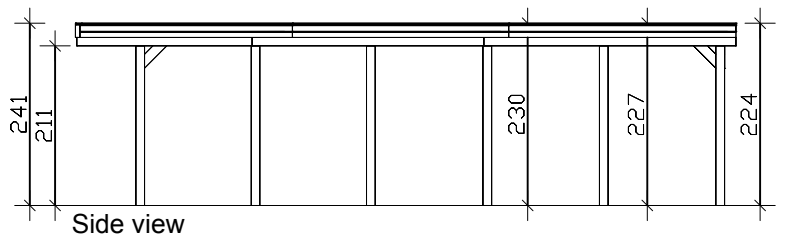
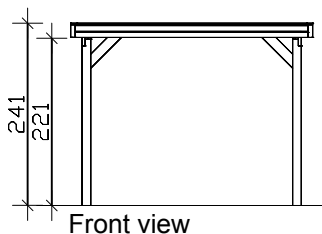

Scale 1:100

Single carport 314 x 555/708/860cm

Technical Information / Construction Description

Type of wood	Pine, impregnated / iron parts: galvanized
Posts	8/10/12 each 11,5x11,5cm
Roofing	Roof panels of plastic, grey (-61) or aluminium, bare (-50) alternatively: Roof board incl. EPDM foil (-35)
Snow load	sk = 1,25kN/m ²
Blind	Circulating wood profile
Width x length	314 x 555/708/860cm (roofed area)
Tot. height / entrance	241-230/227/224cm / front 221cm, rear 210/207/204cm
Area / building volume	17,43/22,23/27,00m ² / 41,04/52,02/62,78m ³
Package dimensions	W x L x H 118 x 315 x 24-41cm / 260-398kg
Including	Mounting hardware (incl. post anchors), Upper struts, set-up instructions

Friesland Flat roof



397x555cm

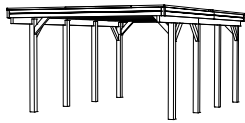

314119

397x708cm

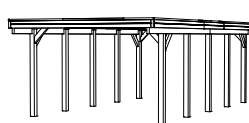

314133

397x860cm

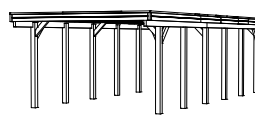

314157

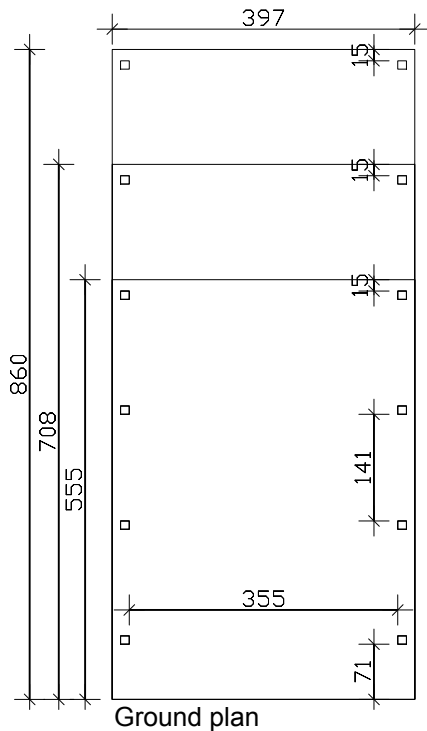

Including anchors for casting into concrete !

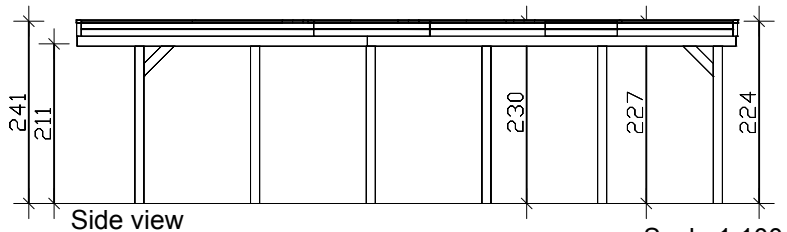
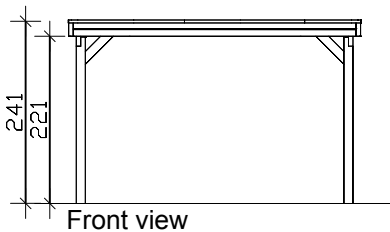

Scale 1:100

Single carport 397 x 555/708/860cm

Technical Information / Construction Description

Type of wood	Pine, impregnated / iron parts: galvanized
Posts	8/10/12 each 11,5x11,5cm
Roofing	Roof panels of plastic, grey (-61) or aluminium, bare (-50) alternatively: Roof board incl. EPDM foil (-35)
Snow load	sk = 1,25kN/m ²
Blind	Circulating wood profile
Width x length	397 x 555/708/860cm (roofed area)
Tot. height / entrance	241-230/227/224cm / front 221cm, rear 210/207/204cm
Area / building volume	22,03/28,11/34,14m ² / 51,89/65,77/79,38m ³
Package dimensions	W x L x H 118 x 387 x 30-45cm / 290-420kg
Including	Mounting hardware (incl. post anchors), Upper struts, set-up instructions

Friesland Flat roof



557x555cm

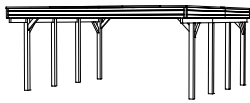

314195

557x708cm

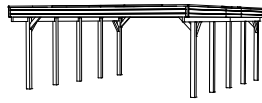

314218

557x860cm

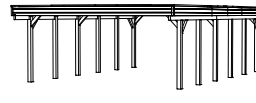

314232

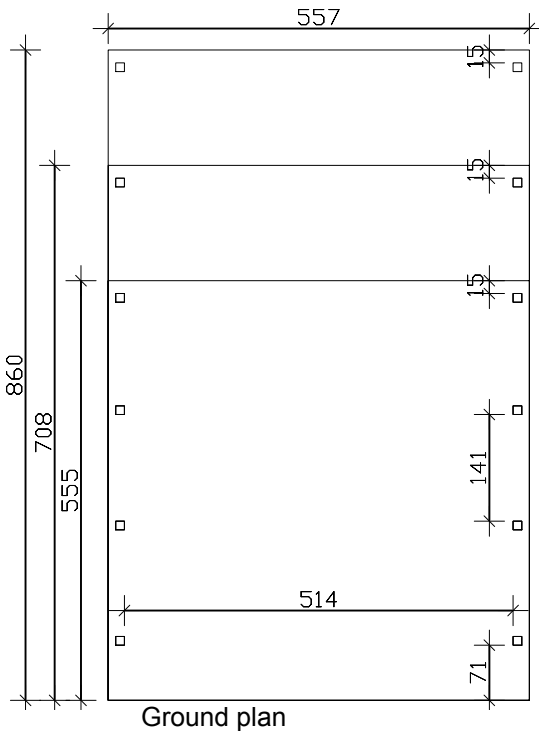

Including anchors for casting into concrete !

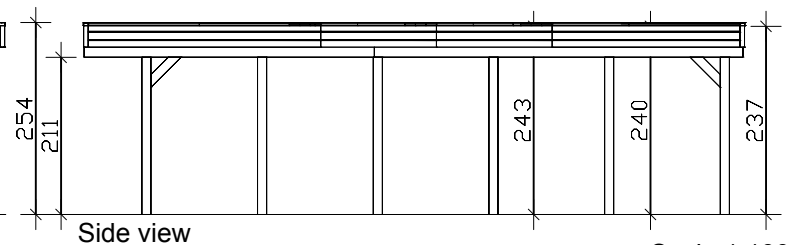
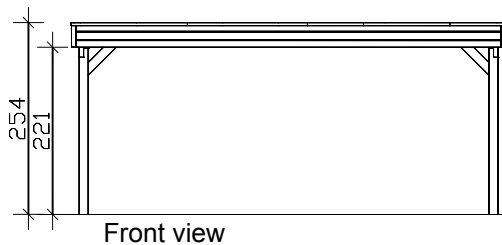

Scale 1:100

Double carport 557 x 555/708/860cm

Technical Information / Construction Description

Type of wood	Pine, impregnated / iron parts: galvanized
Posts	8/10/12 each 11,5x11,5cm
Roofing	Roof panels of plastic, grey (-61) or aluminium, bare (-50) alternatively: Roof board incl. EPDM foil (-35)
Snow load	sk = 1,25kN/m ²
Blind	Circulating wood profile
Width x length	557 x 555/708/860cm (roofed area)
Tot. height / entrance	254-243/240/237cm / front 221cm, rear 210/207/204cm
Area / building volume	30,91/39,44/47,90m ² / 76,82/97,41/117,60m ³
Package dimensions	W x L x H 118 x 560 x 50-55cm / 350-490kg
Including	Mounting hardware (incl. post anchors), Upper struts, set-up instructions