

Odenwald Designcarport Flat roof

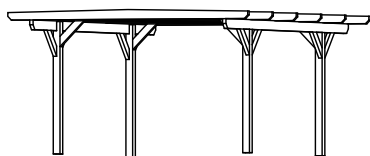

4018211 **24603 8** with straight head bands

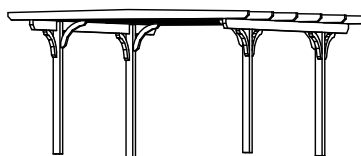

4018211 **24604 5** with round head bands

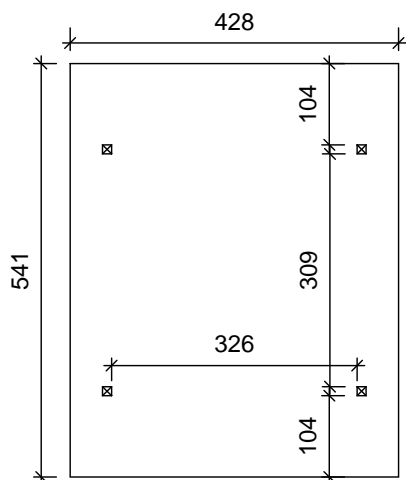

Ground plan

- Load bearing structural parts of laminated timber -
- Slope on either side -

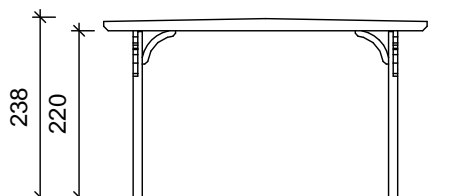

Front view

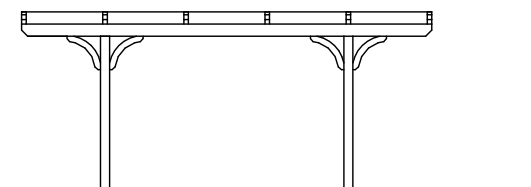

Side view

Scale 1:100

Single carport 428x541cm

Technical information / Construction Description

Type of wood / iron parts	Pine, untreated, construction wood, glued / galvanized
Posts	12x12x220cm
Head bands	straight or round
Roofing	double bar 10mm, transparent
Snow load	sk= 1.25kN/m ²
Width x length	428x541cm
Tot. height / entrance	238cm / 220cm
Area / building volume	23.15m ² / 54,65m ³
Including	Mounting hardware (incl. post anchors, without concrete), Upper struts as illustrated, set-up instructions

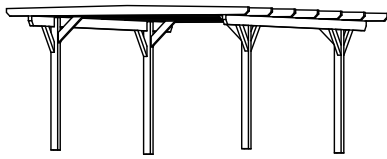

4018211 **24605 2** with straight head bands

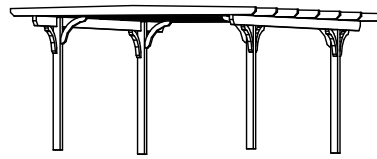

4018211 **24606 9** with round head bands

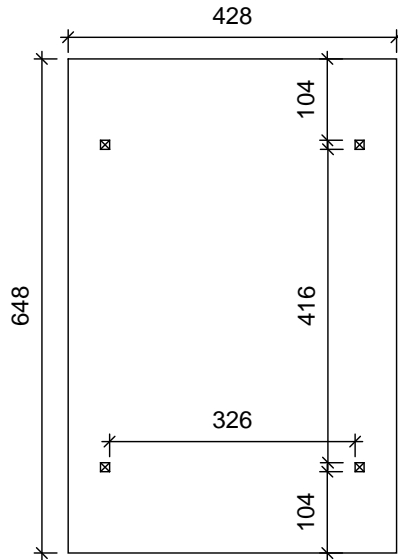

Ground plan

- Load bearing structural parts of laminated timber -
- Slope on either side -

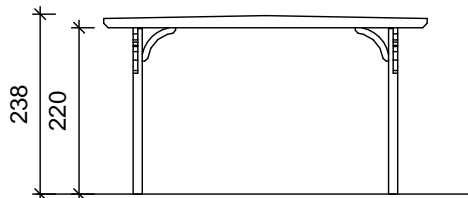

Front view

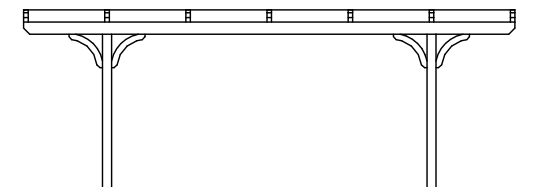

Side view

Scale 1:100

Single-Carport 428x648cm

Technical information / Construction Description

Type of wood / iron parts	Pine, untreated, construction wood, glued / galvanized
Posts	12x12x220cm
Head bands	straight or round
Roofing	double bar 10mm, transparent
Snow load	sk= 1.25kN/m ²
Width / lenght	428x648cm
Tot. high / entrance	238cm / 220cm
Area / building volume	27.73m ² / 65,45m ³
Including	Mounting hardware (incl. post anchors, without concrete), Upper struts as illustrated, set-up instructions



4018211 **24608 3** with straight head bands

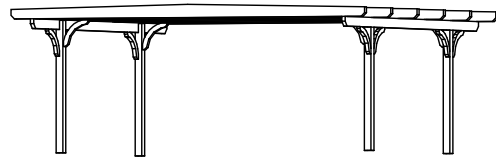

4018211 **24609 0** with round head bands

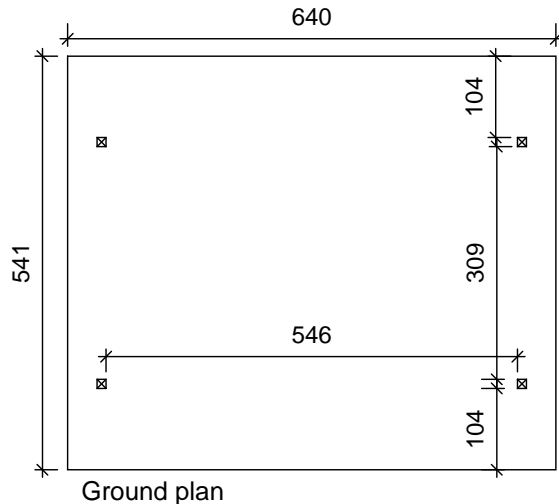

- Load bearing structural parts of laminated timber -
- Slope on either side -

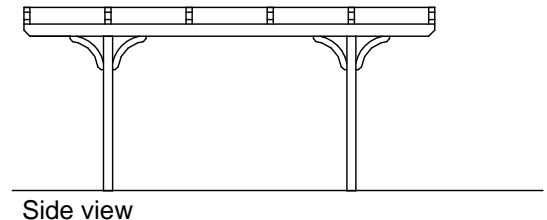
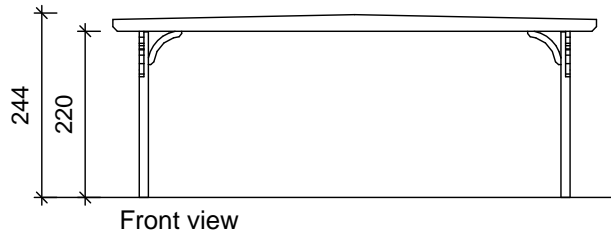

Scale 1:100

Double carport 640x541cm

Technical Information / Construction Description

Type of wood / iron parts	Pine, untreated, construction wood, glued / galvanized
Posts	12x12x220cm
Head bands	straight or round
Roofing	double bar 10mm, transparent
Snow load	sk= 1.25kN/m ²
Width x length	640x541cm
Tot. height / entrance	244cm / 220cm
Area / building area	34,62m ² / 83,36m ³
Including	Mounting hardware (incl. post ancrs, without concrete), Upper struts as illustrated, set-up instructions

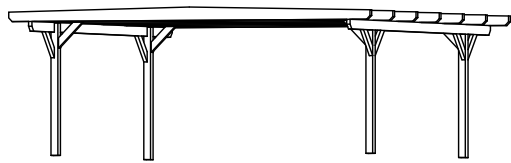

4018211 **24610 6** with straight head bands



4018211 **24611 3** with round head bands

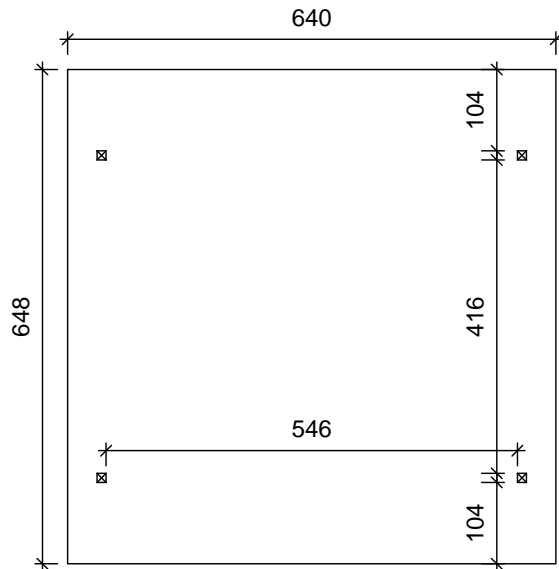

Ground plan

- Load bearing structural parts of laminated timber -
- Slope on either side -

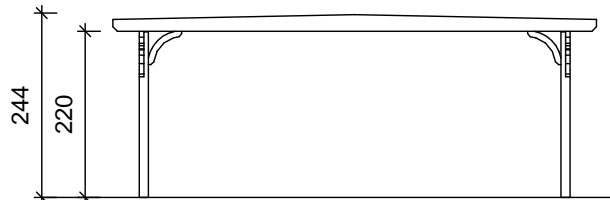

Front view

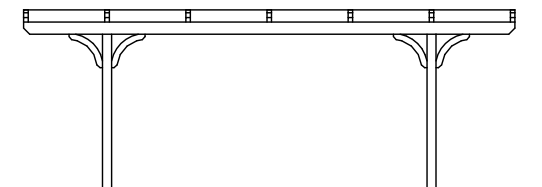

Side view

Scale 1:100

Double-Carport 640x648cm

Technical information / Construction Description

Type of wood / iron parts	Pine, untreated, construction wood, glued / galvanized
Posts	12x12x220cm
Head bands	straight or round
Roofing	Double bar 10mm, transparent
Snow load	sk= 1.25kN/m ²
Width x length	640x648cm
Tot. height / entrance	244cm / 220cm
Area / buiding volume	41.47m ² / 99,84m ³
Including	Mounting hardware (incl. post anchors, without concrete), Upper struts as illustrated, set-up instruction