

Floor plan, cross-section and elevations M 1:100

Venlo 1 250 x 250cm
Data sheet / construction description

Venlo

Walls	28mm-wooden planks , untreated
Roof	19mm profiled wood , untreated
Floors	19mm floor planks , untreated
Ground supports	4 each 60 x 60mm , impregnated
Iron parts	galvanized
Width x depth	250cm x 250cm
Height of roof	252cm (in front) / 237cm (in back) / 255cm (top edge roof blind)
Area / building volume	6,25m² / 15,94m³
Roof inclination	~ 3° / snow load max. sk = 1,50kN/m²
Roof extension	around circumference 20cm / roof surface 7,98m²
Packaging unit	Width x length x height 120 x 290 x 45cm / 580kg
EAN	4018211 603206
Inclusive	1 double door (passage 123,4 x 193cm), 1 layer of tarpaper for roofing

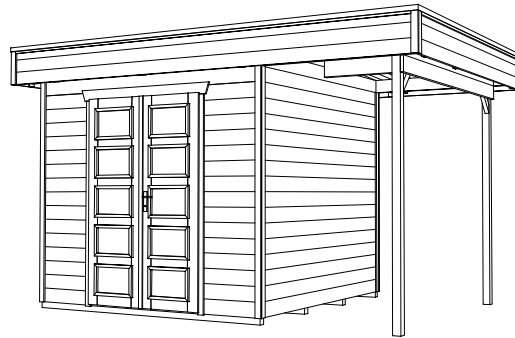

Floor plan, cross-section and elevations M 1:100

Venlo 2 250 x 250cm + 130cm canopy on side
Data sheet / construction description

Venlo

Walls	28mm-wooden planks , untreated
Roof	19mm profiled wood , untreated
Floors	19mm floor planks , untreated
Ground supports	4 each 60 x 60mm , impregnated
Iron parts	galvanized
Width x depth	250cm x 250cm + 130cm x 250cm (canopy on side)
Height of roof	252cm (in front) / 237cm (in back) / 255cm (top edge roof blind)
Area / building volume	9,50m² / 24,23m³
Roof inclination	~ 3° / snow load max. sk = 1,50kN/m ²
Roof extension	around circumference 20cm / roof surface 11,61m ²
Packaging unit	Width x length x height 120 x 423 x 49cm / 648kg
EAN	4018211 603213
Inclusive	1 double door (passage 123,4 x 193cm), 1 layer of tarpaper for roofing

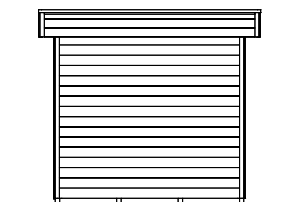
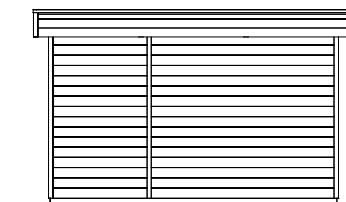
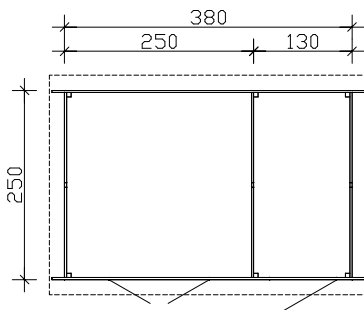
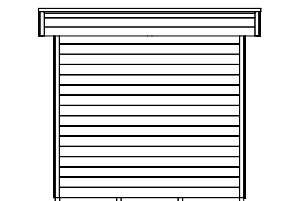
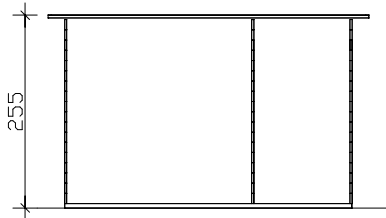
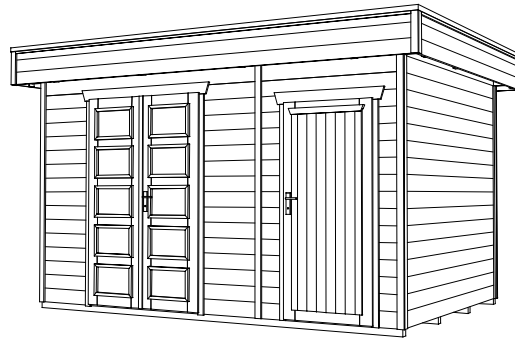

Floor plan, cross-section and elevations M 1:100

Venlo 3 250 x 250cm + 130cm storeroom on side
Data sheet / construction description

Venlo

Walls	28mm-wooden planks , untreated
Roof	19mm profiled wood , untreated
Floors	19mm floor planks , untreated
Ground supports	4 each 60 x 60mm , impregnated
Iron parts	galvanized
Width x depth	250cm x 250cm + 130cm x 250cm (storeroom on side)
Height of roof	252cm (in front) / 237cm (in back) / 255cm (top edge roof blind)
Area / building volume	9,50m² / 24,23m³
Roof inclination	~ 3° / snow load max. sk = 1,50kN/m ²
Roof extension	around circumference 20cm / roof surface 11,61m ²
Packaging unit	Width x length x height 120 x 442 x 53cm / 823kg
EAN	4018211 603220
Inclusive	1 double door (passage 123,4 x 193cm), 1 single door (pas- sage 78,5 x 179,5cm), 1 layer of tarpaper for roofing