

















Assembly video

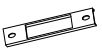

Montagevideo

Pos	Piece list - Stückliste - Liste des pièces - Elementi - Stuklijst - Tükítabel	Q	P (mm)	L (mm)
12	Upper door jamb - Türrahmen oben - Cadre de porte supérieur - Telaio superiore della porta - Bovendorpel - Ukse ülemine leng 	1	35x60	1982
9	Doorstep - Swelle - Seuil de porte - Callare - Drempel - Lävepakki ukseavale 	1	35x60	1982
10-11	Door jamb - Türrahmen - Cadre de porte - Telaio montante della porta - Deurframe - Ukse leng 	2	32x63	2000
13	Door - Tür - Porte - Porte - Deur - Uks	1		
14	Door - Tür - Porte - Porte - Deur - Uks	1		
RS2	Railing strip - Begrenzungsleiste - Rembarde - Sbarra - Afscheidingslijst - Piirdelaud 	1	18x70	1982
RS4	Railing strip - Begrenzungsleiste - Rembarde - Sbarra - Afscheidingslijst - Piirdelaud 	1	18x70	2000
RS7	Railing strip - Begrenzungsleiste - Rembarde - Sbarra - Afscheidingslijst - Piirdelaud 	1	18x90	2116
RS8	Railing strip - Begrenzungsleiste - Rembarde - Sbarra - Afscheidingslijst - Piirdelaud 	1	18x90	2126
FF2	Fixing fillet - Fixierungsleiste - Profil de fixation - Massello di fissaggio - Bevestiging lijstwerk - Tenderlijst 	1	15x45	2026
FF3	Fixing fillet - Fixierungsleiste - Profil de fixation - Massello di fissaggio - Bevestiging lijstwerk - Tenderlijst 	1	38x46	1980
FF4	Fixing fillet - Fixierungsleiste - Profil de fixation - Massello di fissaggio - Bevestiging lijstwerk - Tenderlijst 	1	38x46	2026
HS33	Screw for door jamb - Schraube für Türrahmen - Vis de fixation partie haute avec montants du cadre de porte - Viti x fissaggio montanti porte - Schroef voor deurkozijn - Krugi ukse lengile 	8	5x40	
HS12	Screw for door jamb - Schraube für Türrahmen - Vis de fixation partie haute avec montants du cadre de porte - Viti x fissaggio montanti porte - Schroef voor deurkozijn - Krugi ukse lengile 	25	4x40	
HS32	Screw for door jamb - Schraube für Türrahmen - Vis de fixation partie haute avec montants du cadre de porte - Viti x fissaggio montanti porte - Schroef voor deurkozijn - Krugi ukse lengile 	2	4.5x25	
HS16	Screw for door jamb - Schraube für Türrahmen - Vis de fixation partie haute avec montants du cadre de porte - Viti x fissaggio montanti porte - Schroef voor deurkozijn - Krugi ukse lengile 	5	4.5x25	
HS90	Screw for striker plate - Schraube für Halteplatte - Vis de fixation gache de porte - Vite per cerniera a piastra - Schroef voor sloopplaat - Krugi ukse luku vasturauale 	4	4x25	
LV	Stricker for lock - Schließblech für Türschloss - Gache de porte - L'attaccante piastra - Sluitplaat voor deurslot - Lukuvastus 	2		

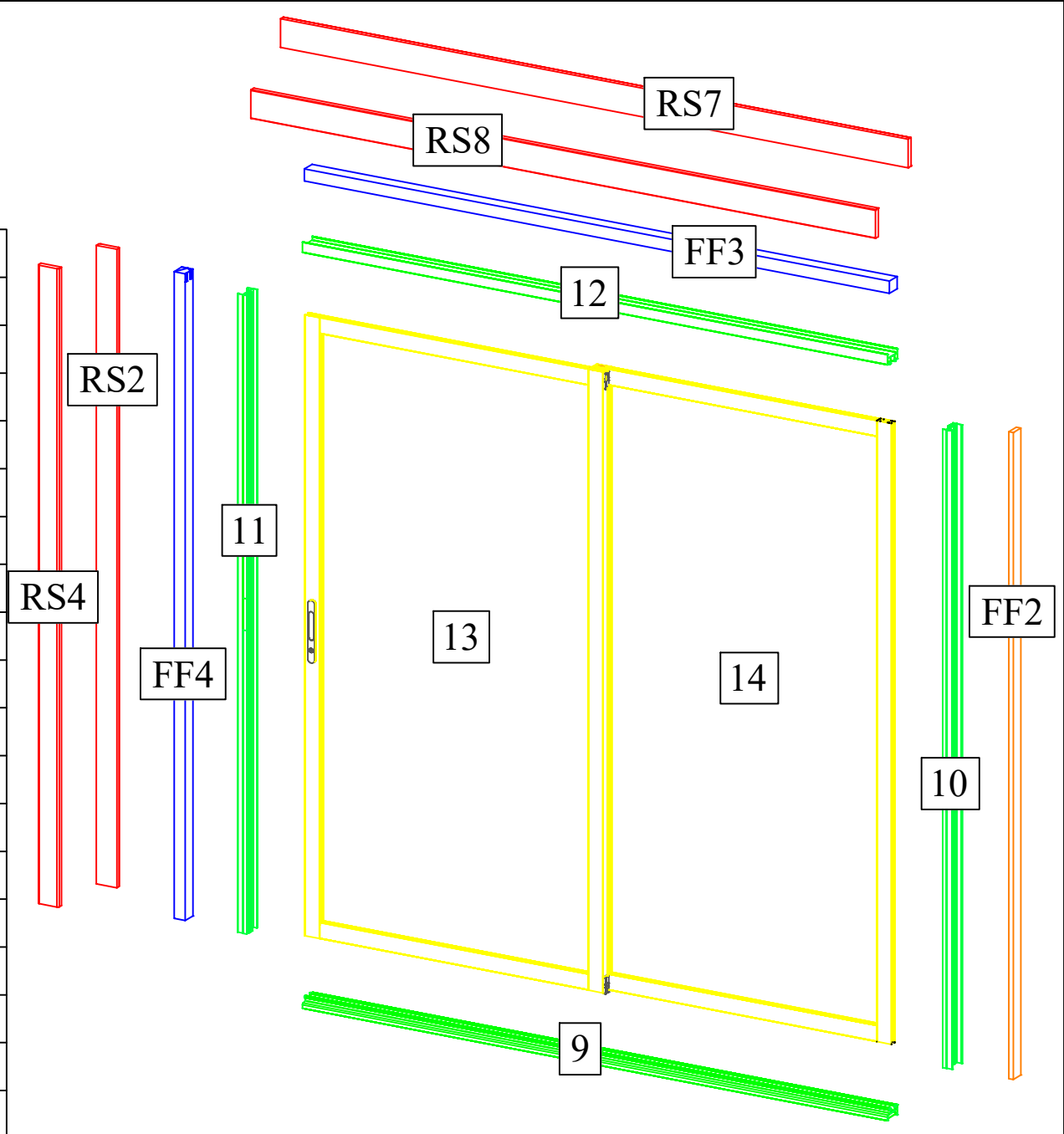

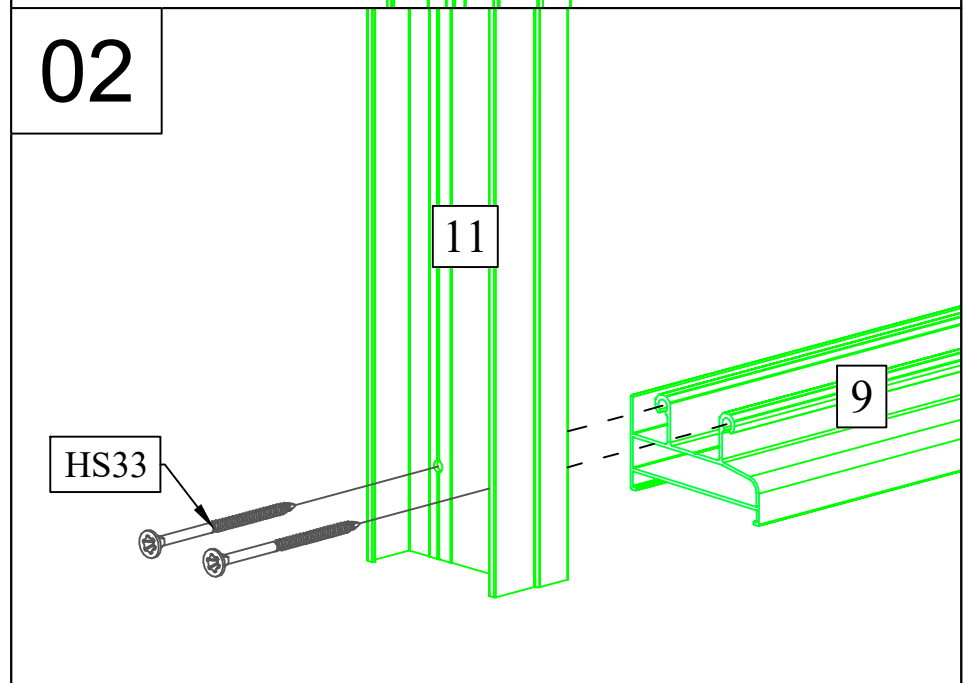
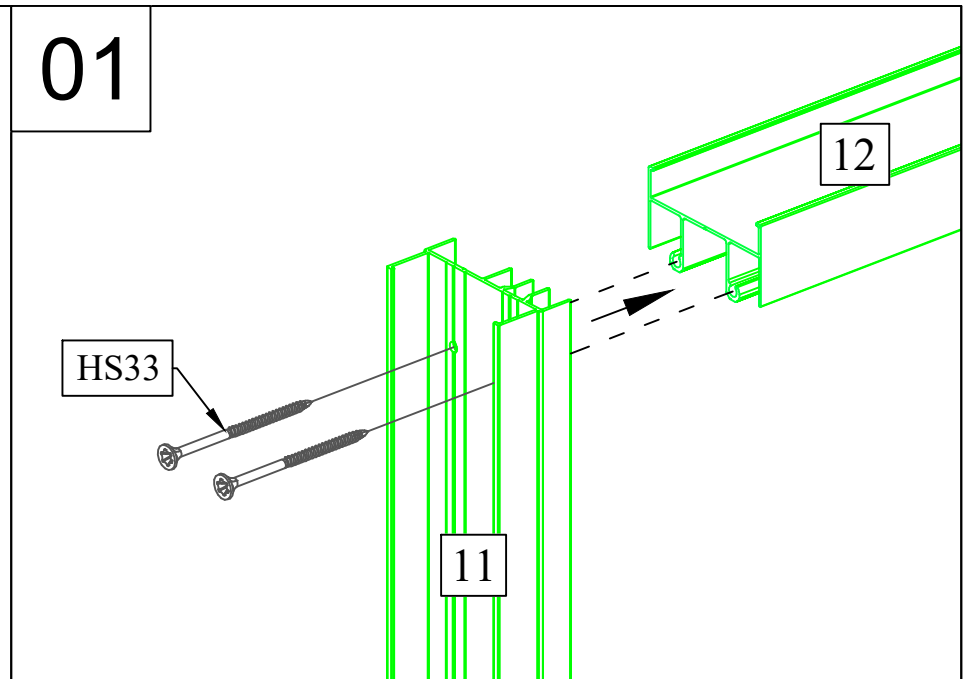
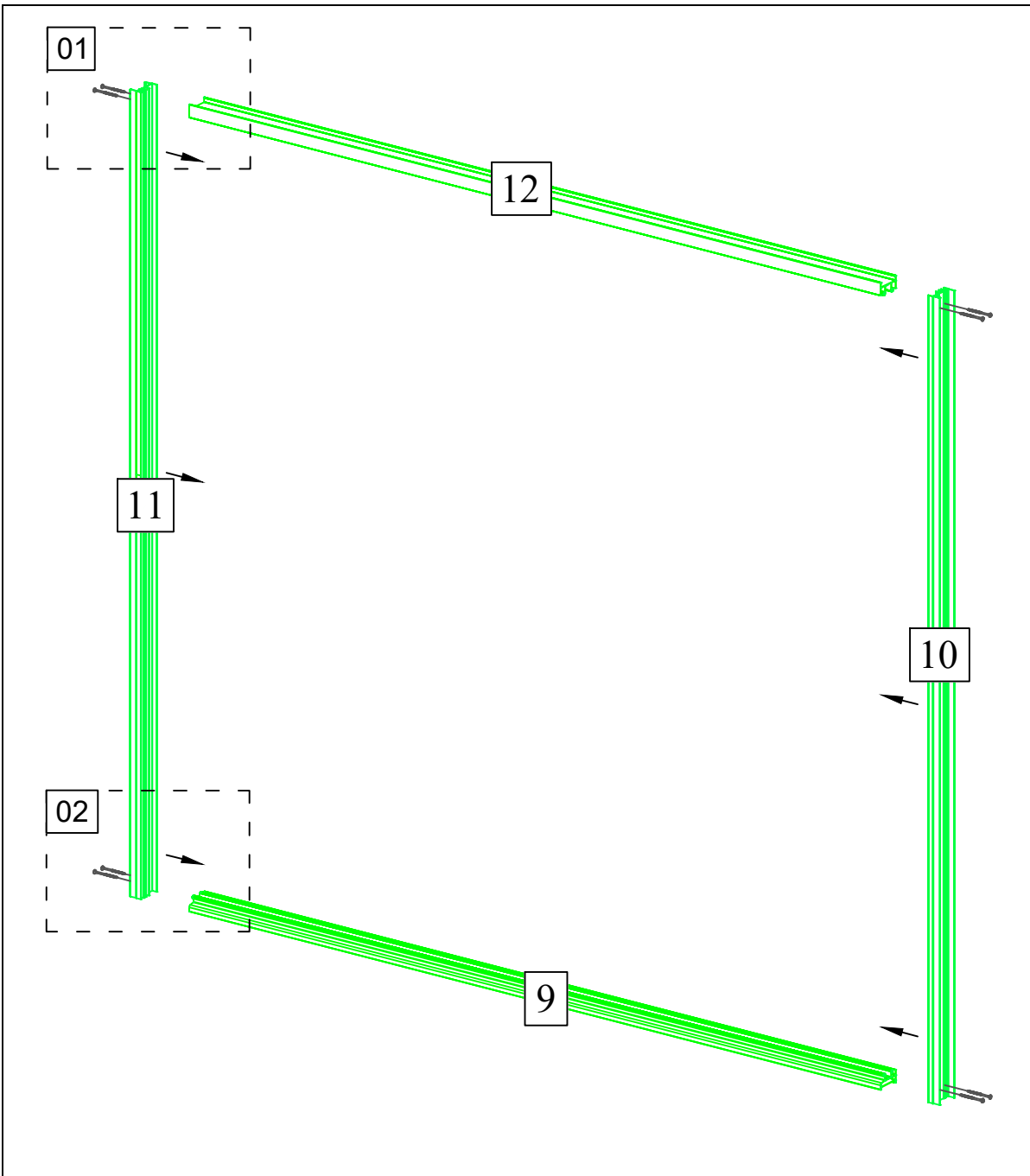

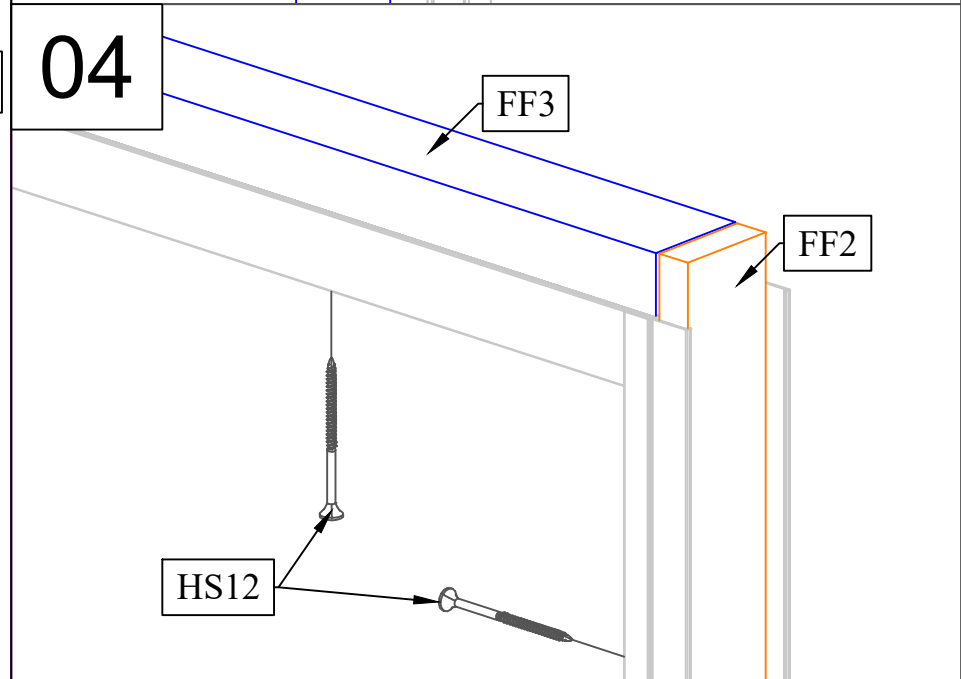
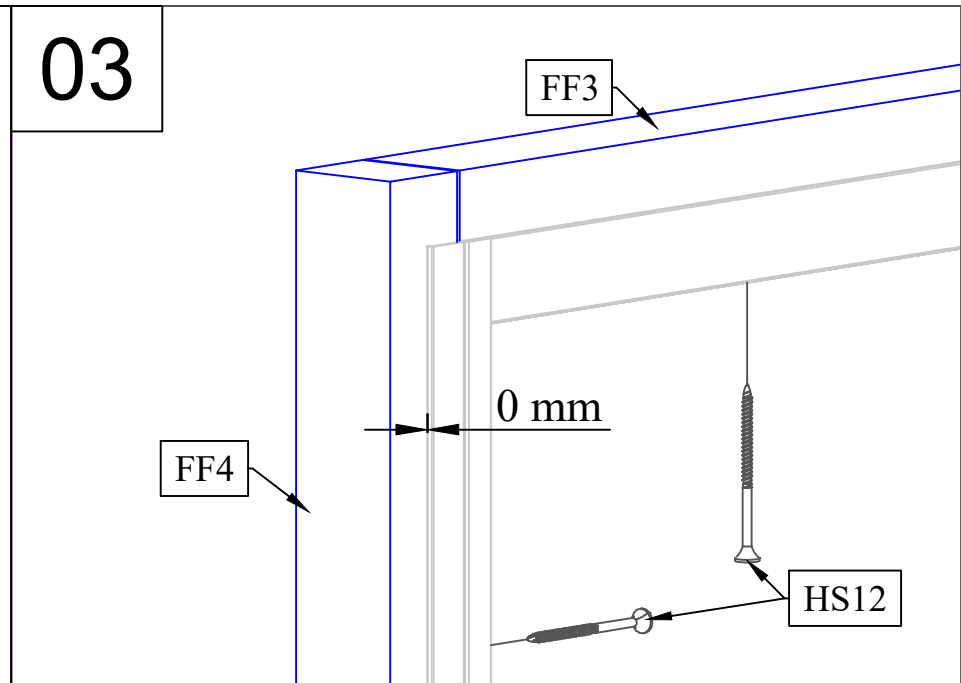
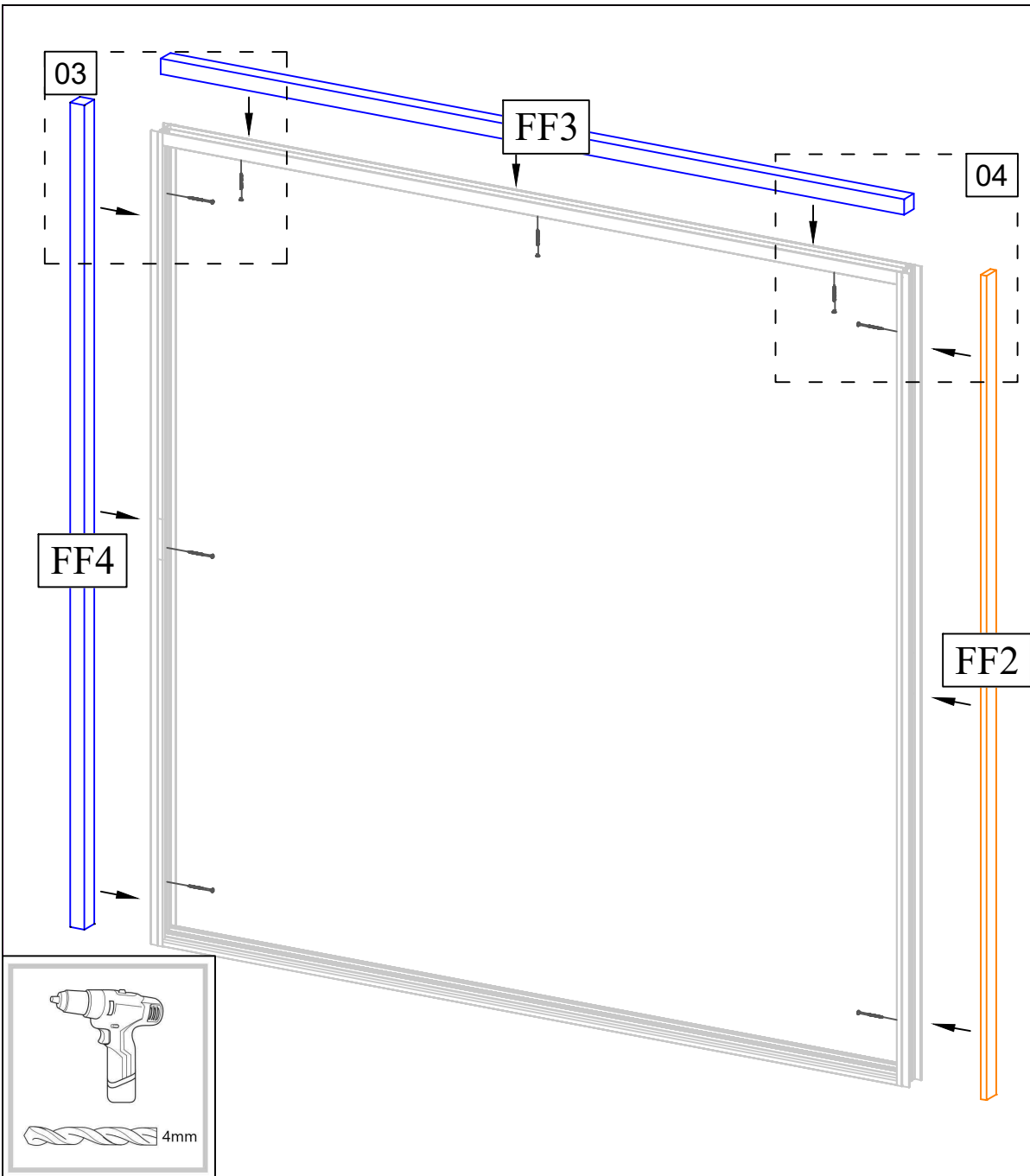

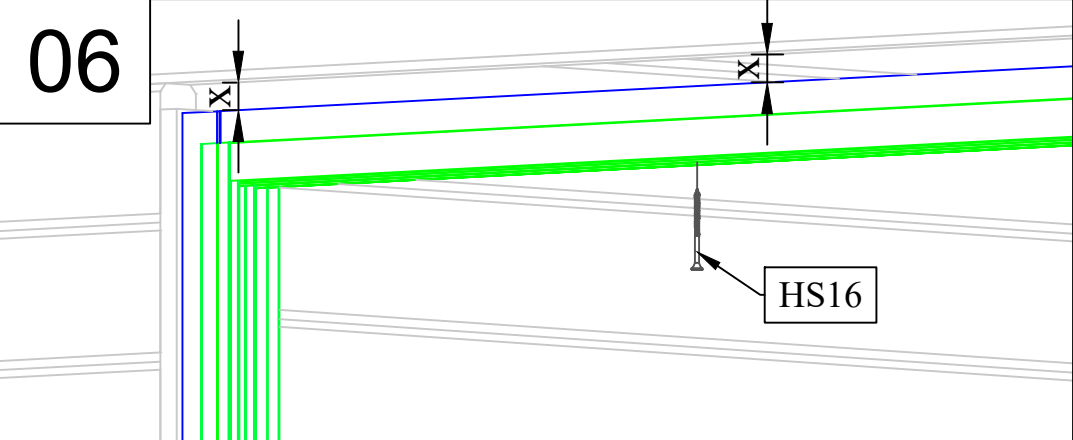
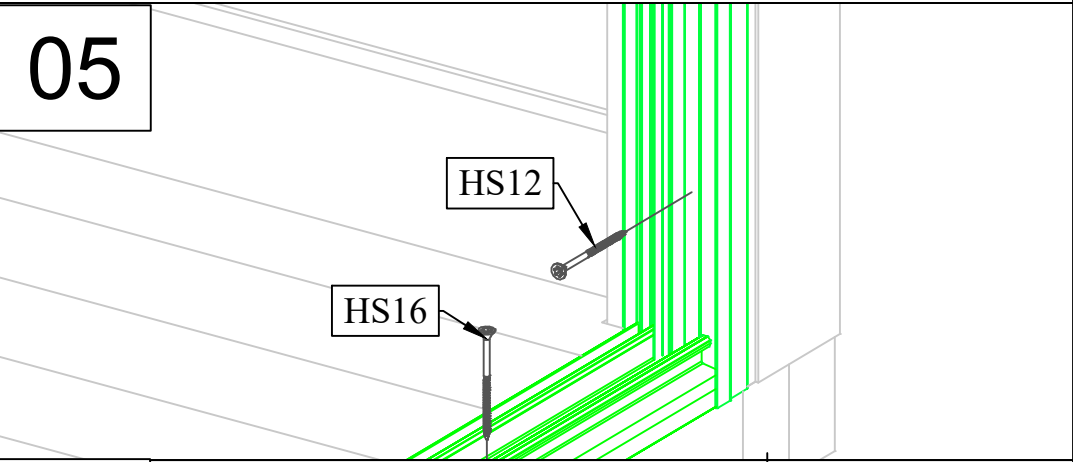
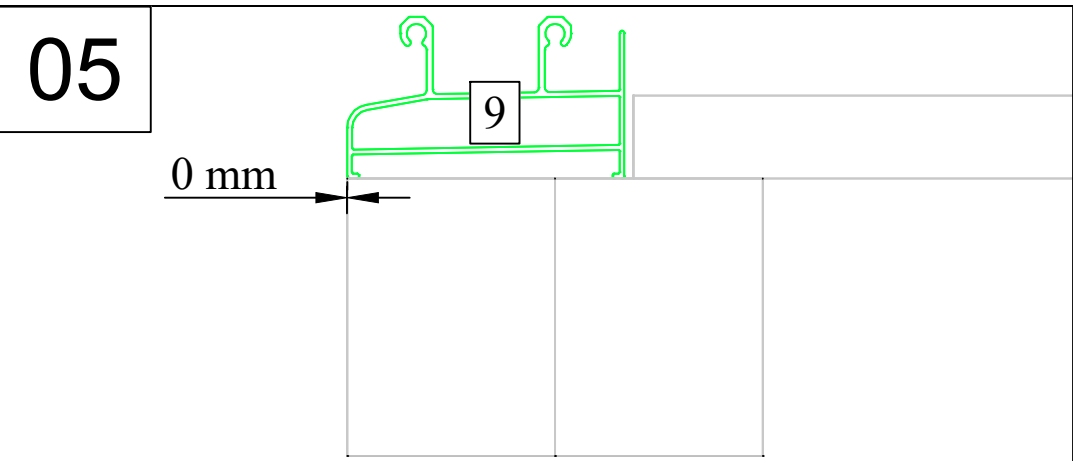
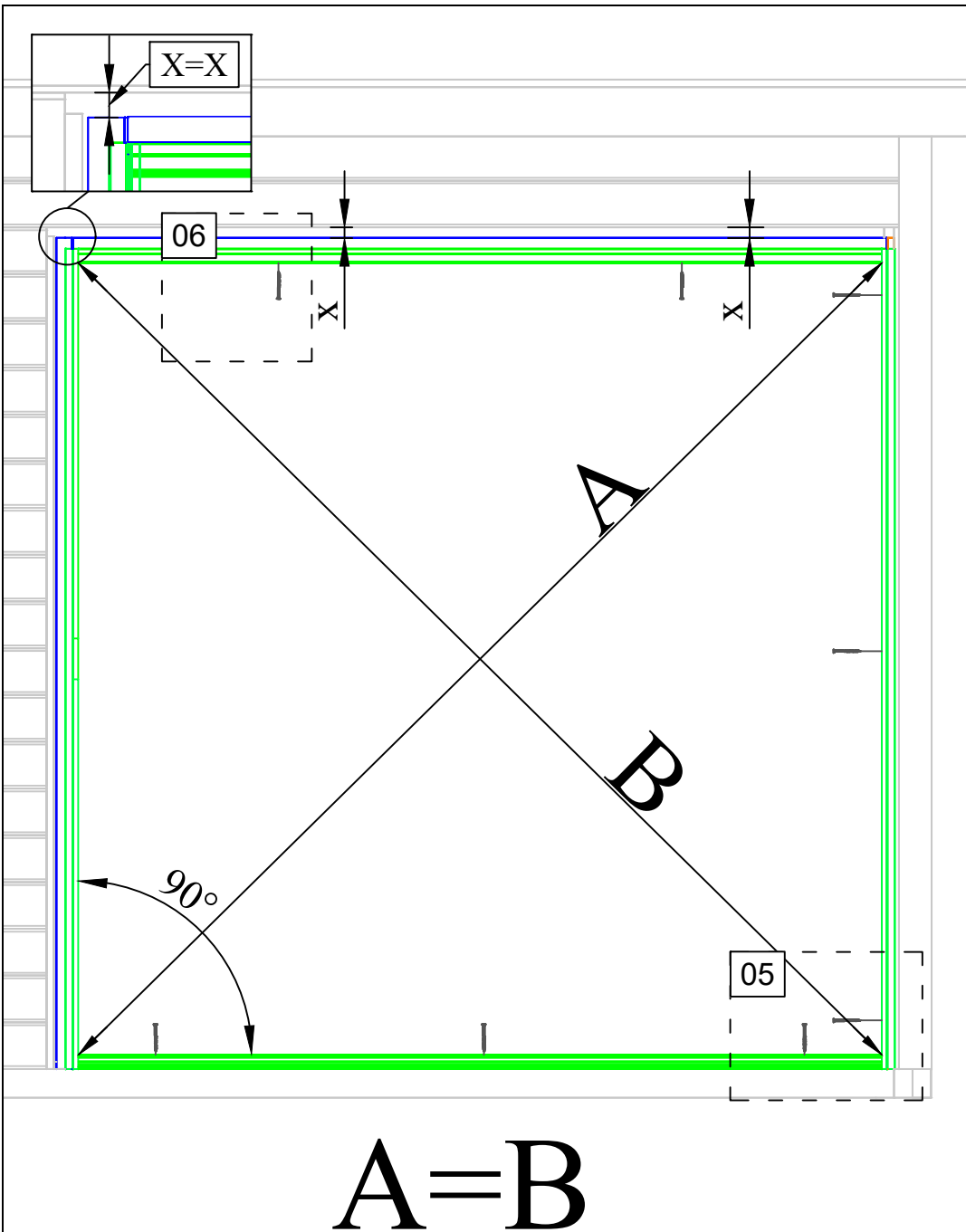

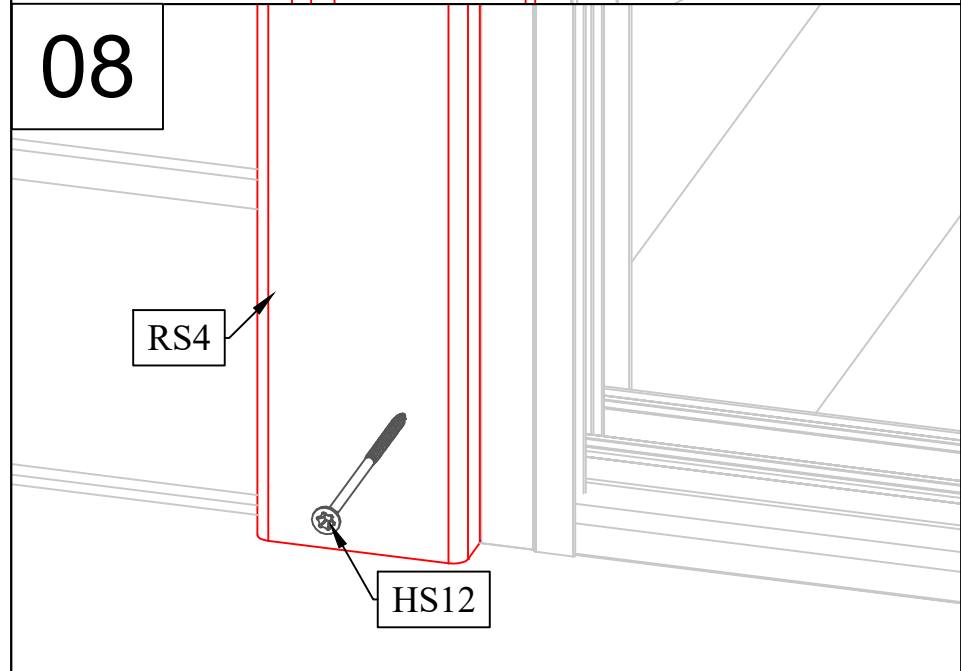
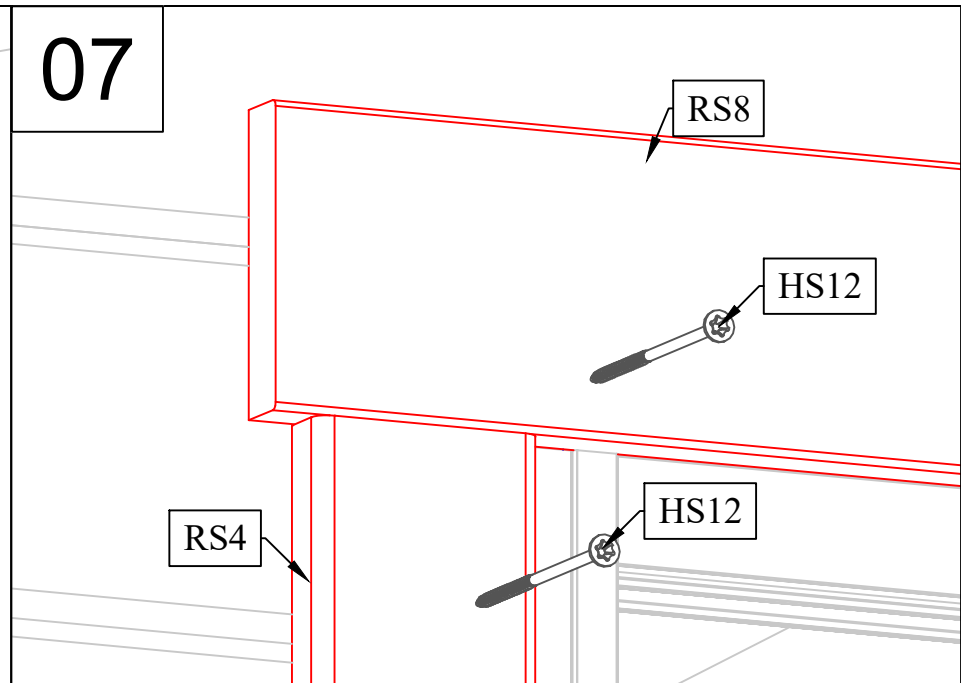
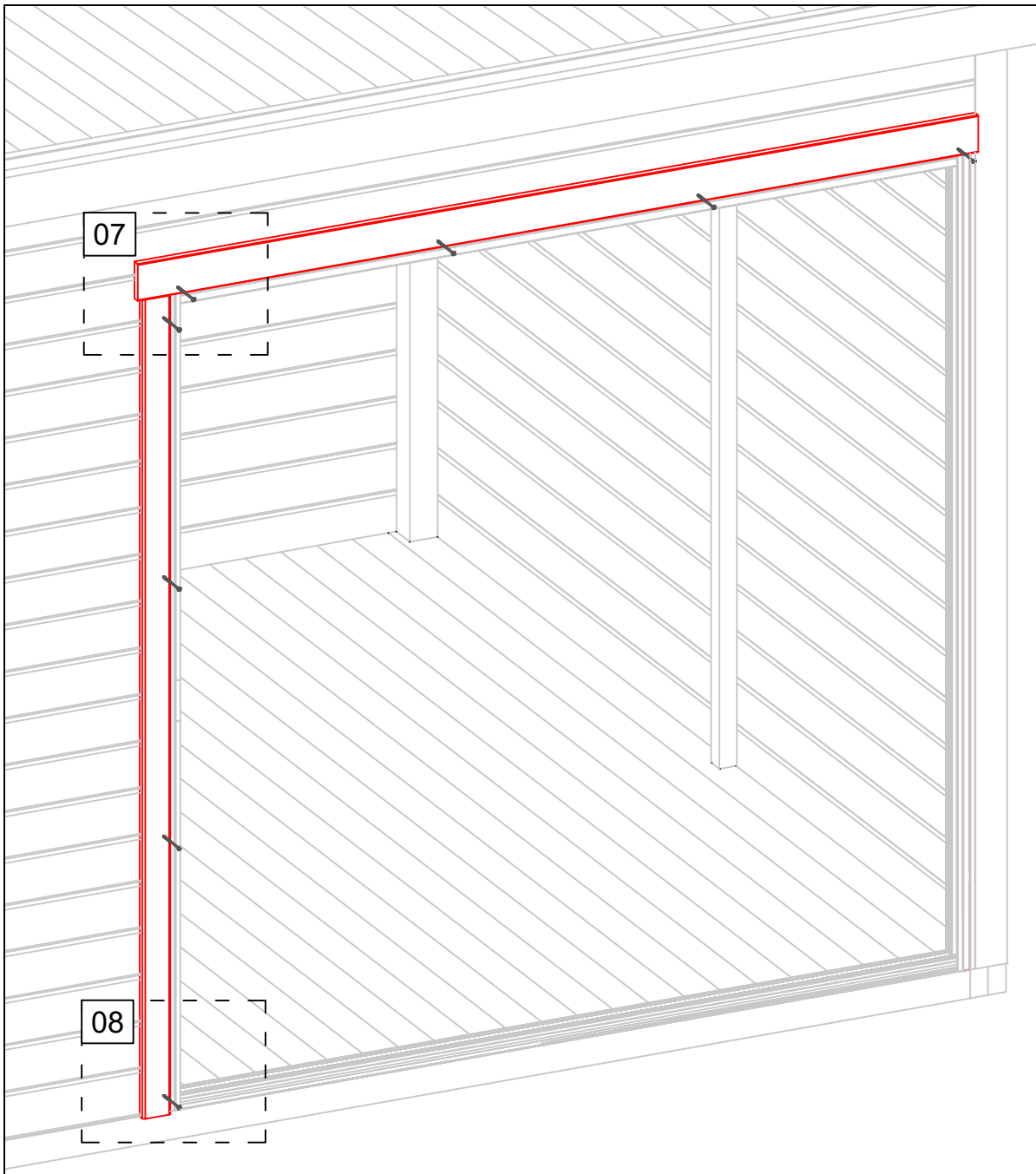

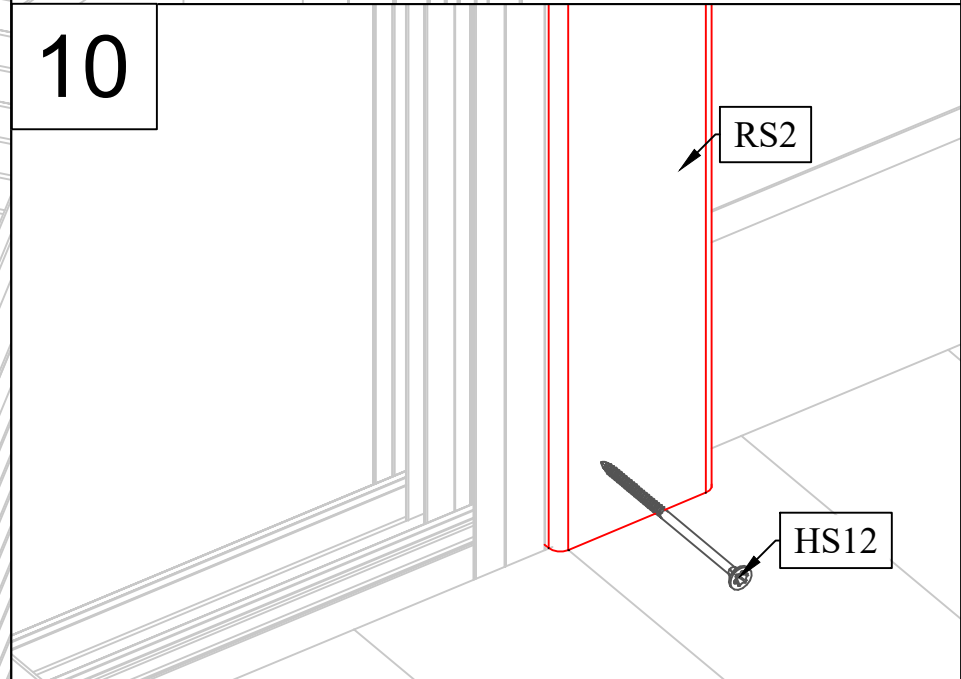
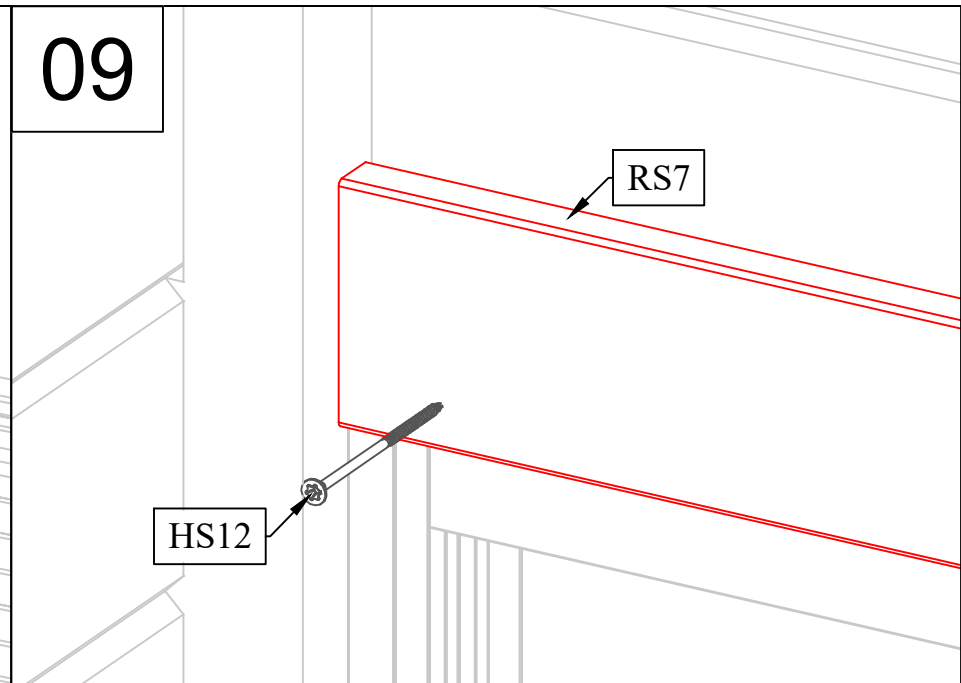
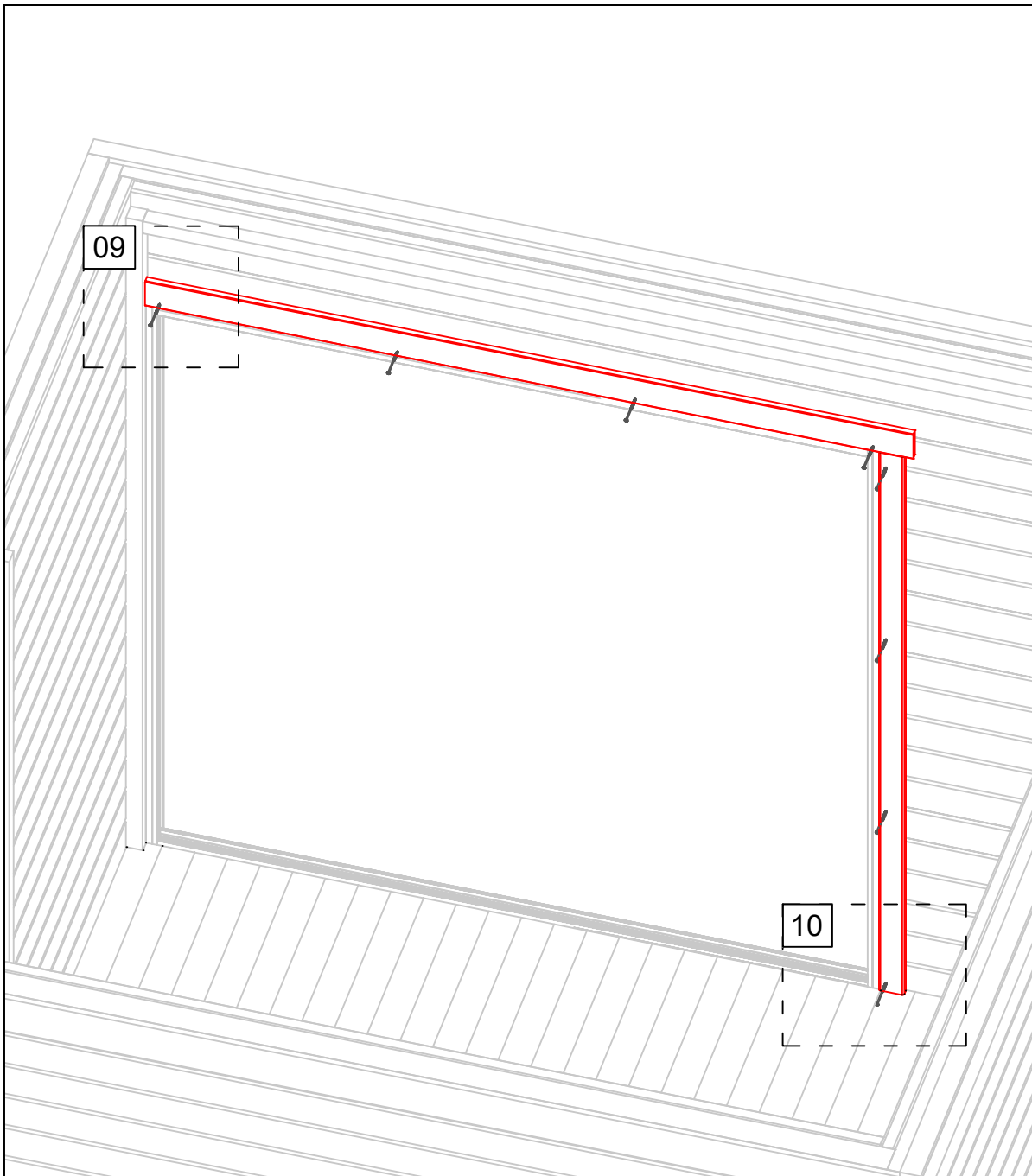

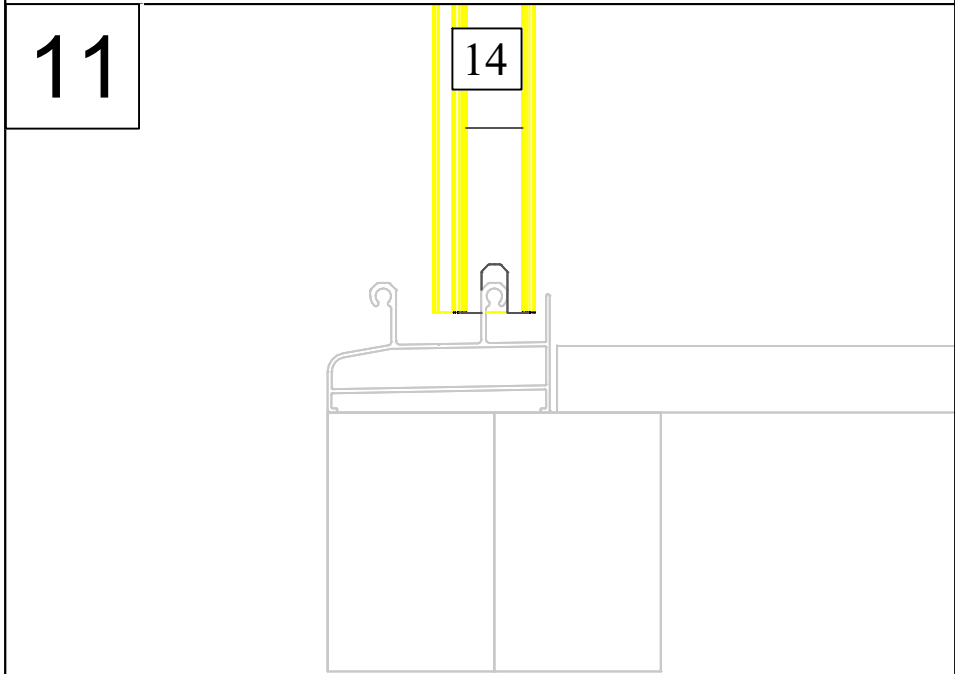
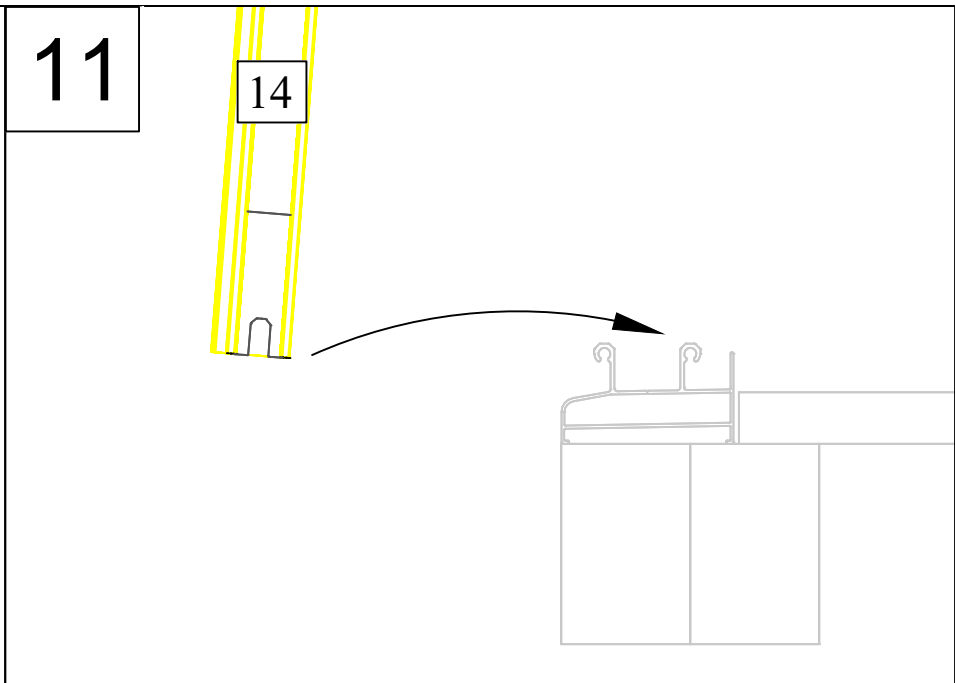
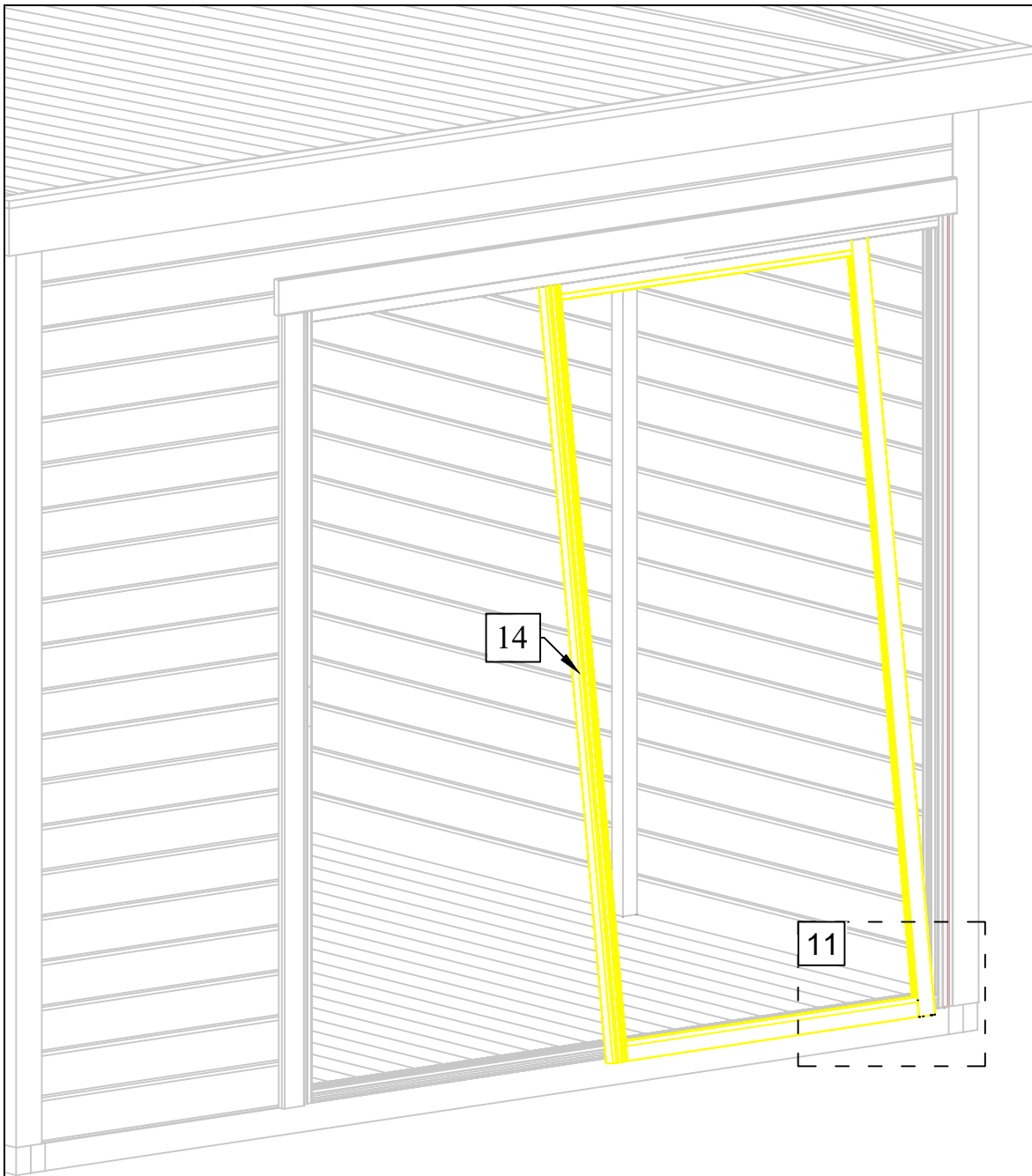

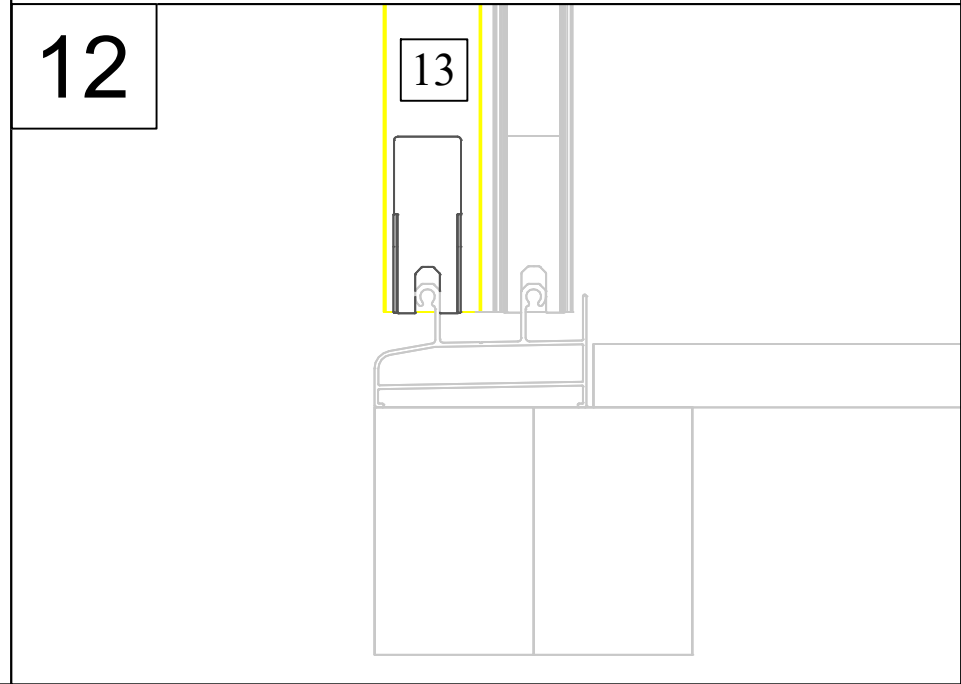
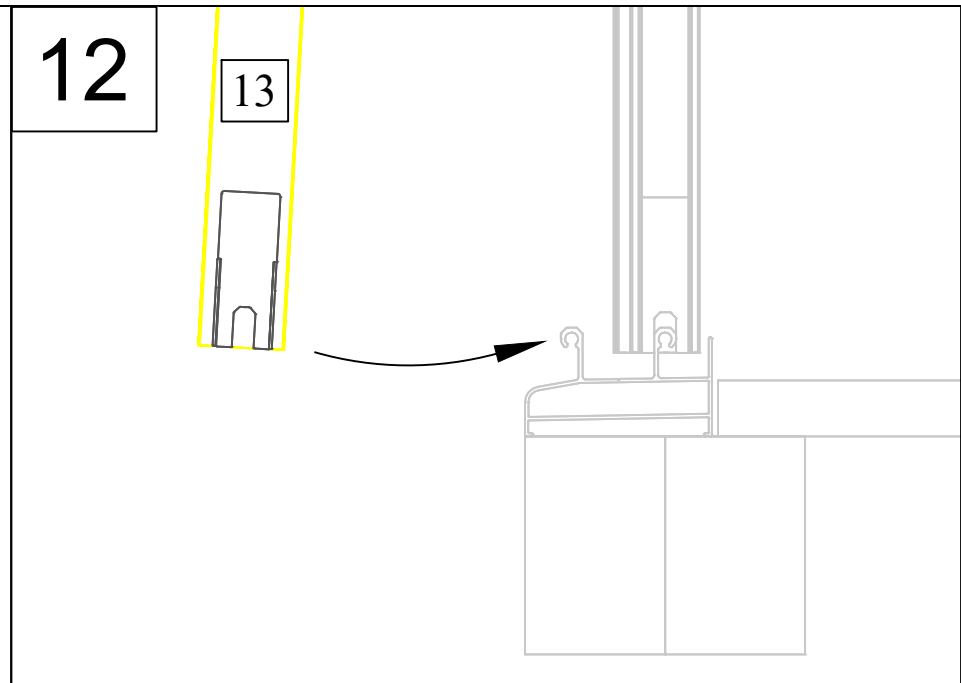
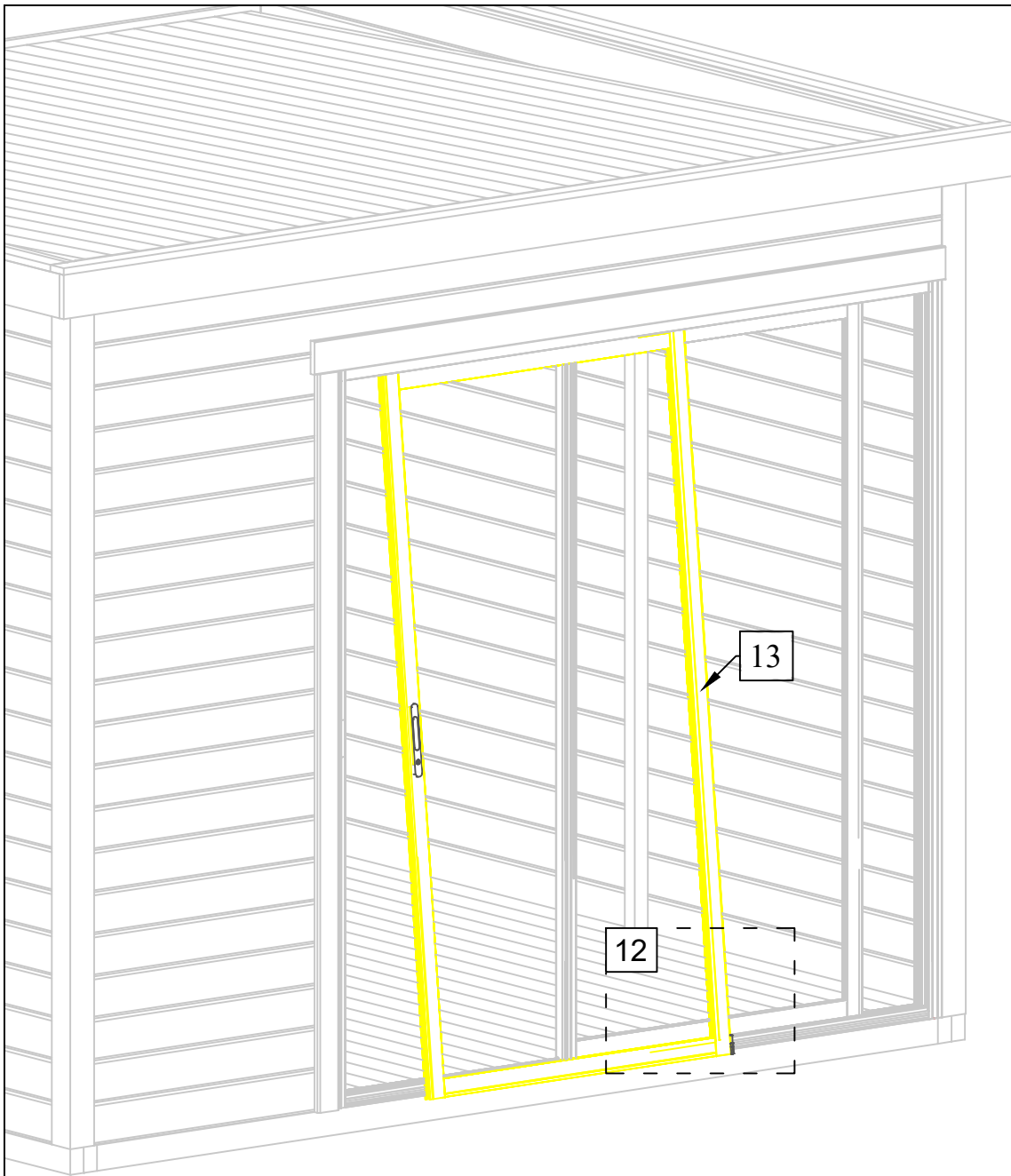

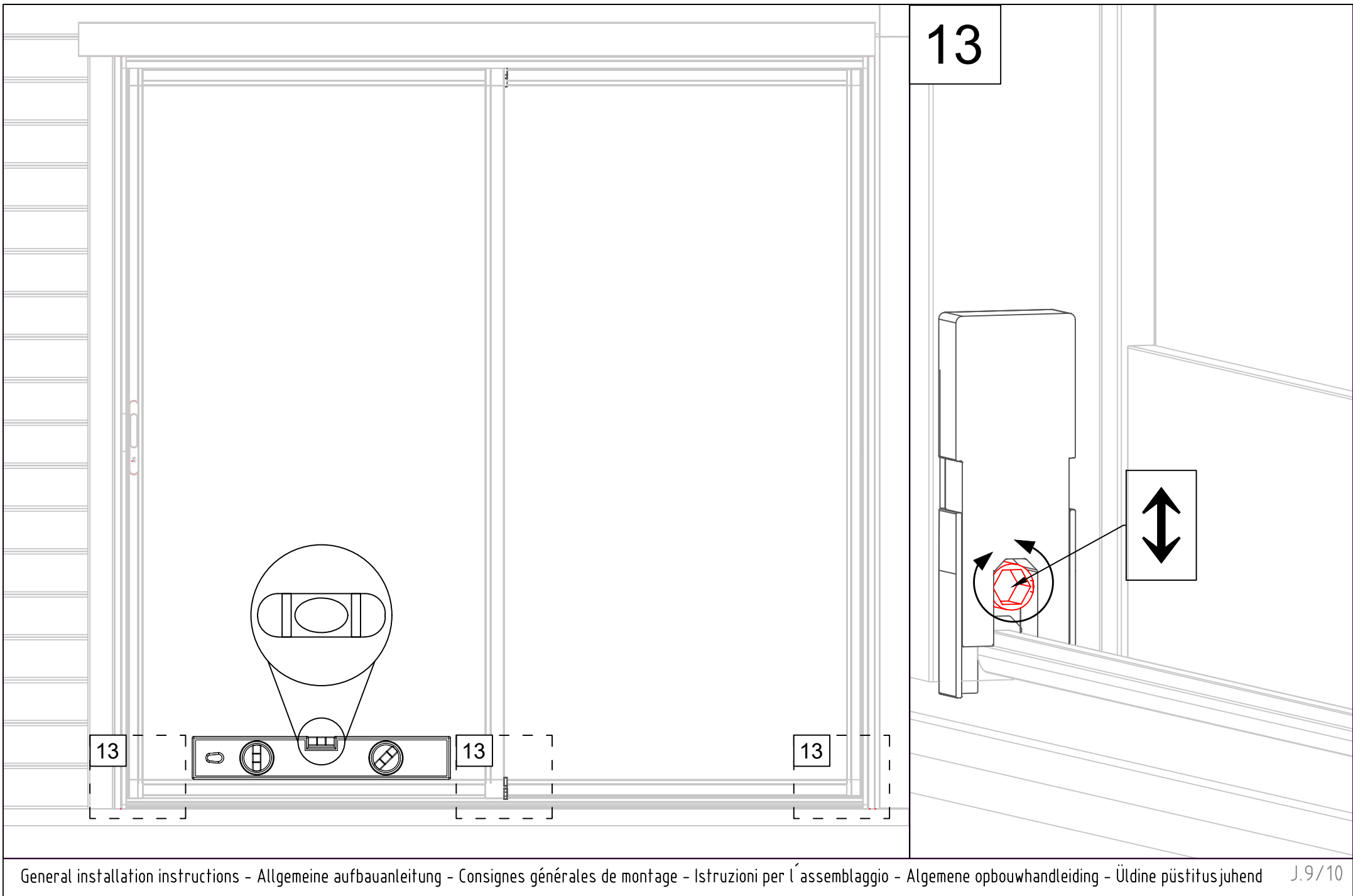

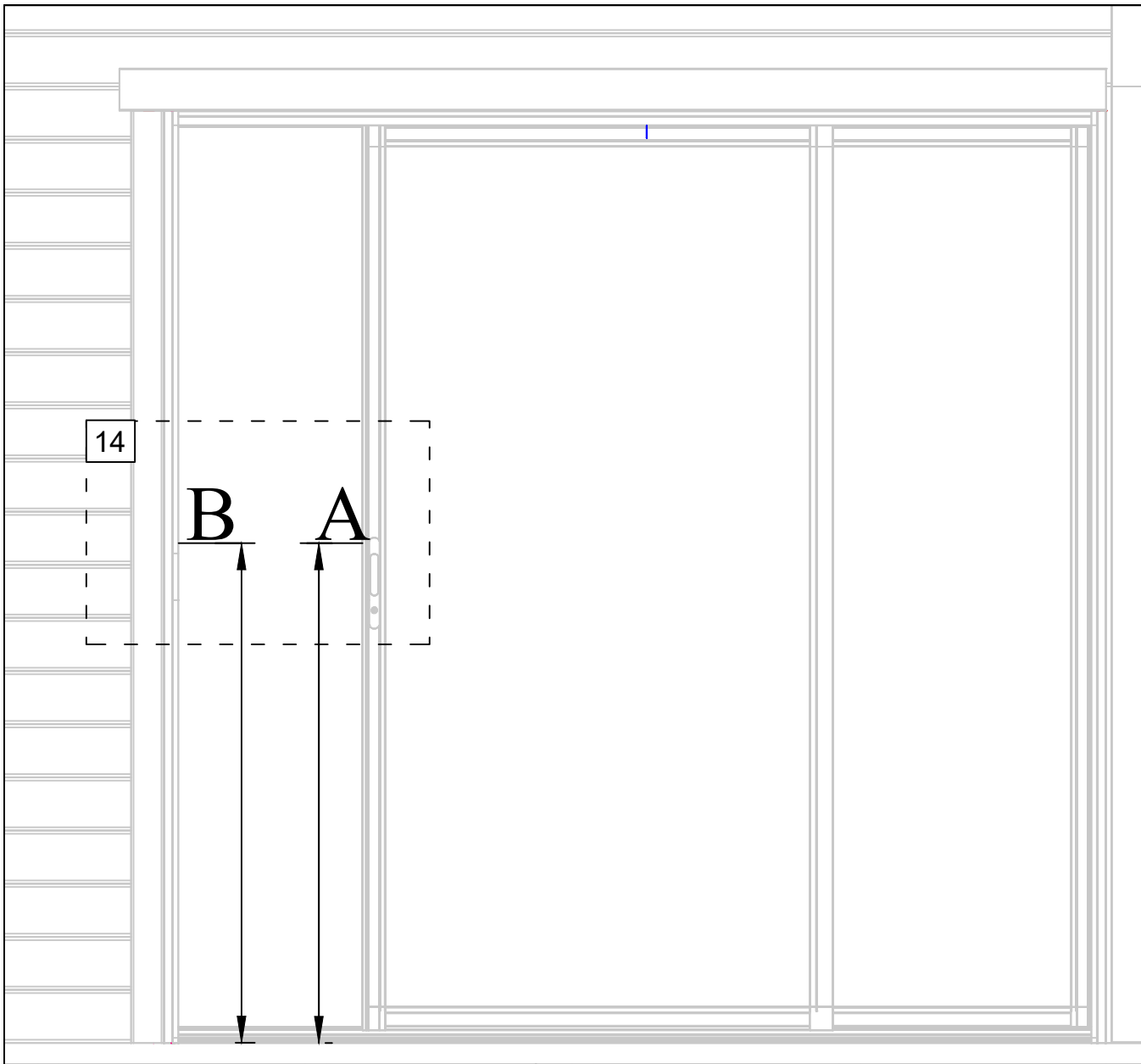

$$A=B$$

